

NEC 2020

Significant Changes

- Public Inputs – 3,730.
- Comments to Public Inputs – 1,930
- First Revisions – 1,400
- Second Revisions – 634
- Correlating Revisions - 73

- Don't Kill Anybody
Please...

New Articles

- Article 242 Overvoltage Protection (Surge Protection) replaces 280 and 285. Now required for dwellings
- Article 311 Medium Voltage Conductors and Cables
- Article 337 Type P Cable (Drilling Rig Cable)
- Article 800 General Requirements for Communications

A framed sign with a decorative border and a central text panel. The sign is mounted on a light-colored wall. The border is dark with a repeating pattern of small, raised, circular motifs. The central panel is white with a black border and contains text in various fonts. The text is as follows:

This Room Is Equipped With
Edison Electric Light.

Do not attempt to light with
match. Simply turn key
on wall by the door.

— — — — —

The use of Electricity for lighting is in no way harmful
to health, nor does it affect the soundness of sleep.

This Room Is Equipped With

Edison Electric Light.

Do not attempt to light with
match. Simply turn key
on wall by the door.

— — — — —

The use of Electricity for lighting is in no way harmful
to health, nor does it affect the soundness of sleep.

How it was done in the past...

Interpreting the NEC

- Charlie's Rule:



It doesn't say what you think it says, nor what you remember it to have said, nor what you were told that it says, and certainly not what you want it to say.

- If by chance you are an instructor, it doesn't say what you have been saying, and if you're an author, it doesn't say what it's intended to say.

- Then what does it say? It says what it says. So if you want to know what it says, stop trying to remember what it says, don't ask anyone what it says and don't think it says what you want it to say.

- Go back and read it again and pay attention as though you were reading it for the first time. If you don't like what it says, then get involved and try to change it. In the process, you might find out that what it says, it should be saying...

Identify Changes

- Changed Rules identified by shading the text that was changed from the previous edition.
- New rules are not shaded but have a shaded "N" in the margin.
- Relocated rules are treated like new rules with an "N" in the margin.
- Deleted rules are marked with a "." in the left margin.

Revisions

- See back of NEC cover for definition of 

Why do we need an NEC?

- 90.1(A) Safeguarding of persons and property from hazards arising from the use of electricity.
- Not Convenience
- Not Economy
- Not Reliability
- Just Safety



Can you hear me now?



upload in www.top81.com



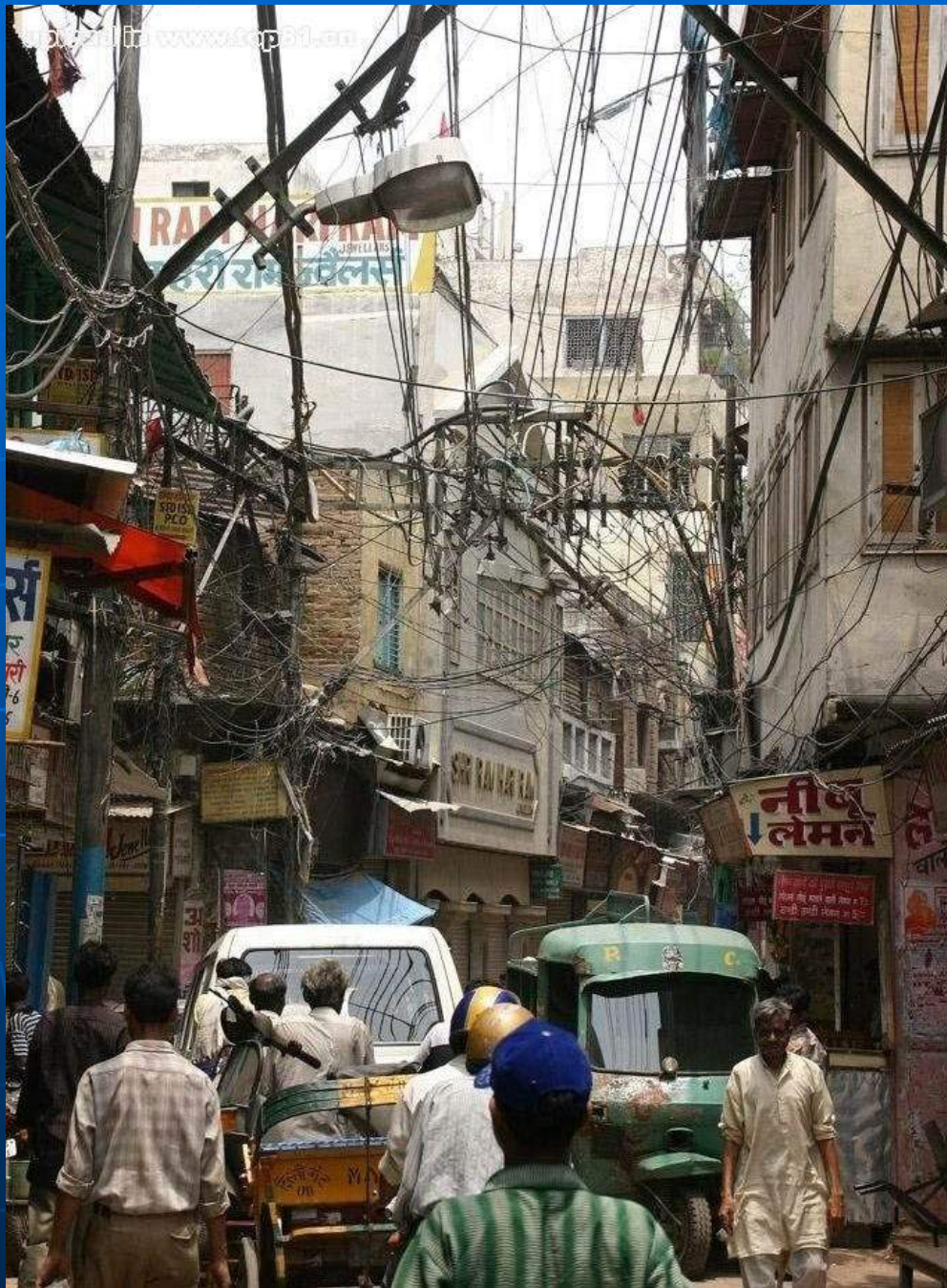



With Code



Let Consumers select the safety upgrades that they want.









Can Light?



Instant Hot!!!??









Article 90

- 90.1 Purpose of the Code
- Clarifies that Chapter 9 tables are applicable as referenced in the NEC.
- Condensed to make purpose of the code more obvious. 90.1(C) from 2011 was removed and made part of (A) then section renumbered.

Article 90

- Explanatory Material.
- Fine Print Notes (FPN's) are gone.
- Replaced by Informational Notes
- FPN's were not supposed to be "enforceable" but we all know that the "fine print" is enforceable!
- Informational Notes clearly convey that they are for information only.

Article 90

- Two Changes to Scope of NEC
- 90.2(A)(5) Installations supplying shore power to ships and watercraft in marinas and boatyards, *including monitoring of leakage current.*
- Installations used to export electric power from vehicles to premises wiring or for bidirectional current flow.

Article 100 Definitions

- Now contains 3 parts
- Part I – General
- Part II – Over 1000 Volts
- Part III – Hazardous (Classified) Locations – Groups definitions for these areas in one place for easy locating.

Article 100 Definitions

- Term must be used in 2 or more articles to be included in article 100. Otherwise it will be defined in .2 of the applicable article.
- Ampacity defined to mean the MAXIMUM current, in amperes, that a conductor can carry ***continuously*** without raising its temperature beyond its insulation temperature rating. - 2011

Article 100 cont'd

- Accessible, Readily (Readily Accessible revised to include the use of "tools
- Building definition changed. No longer refers to "fire doors".
- Definition clarifies that EGC "is part of" an effective ground-fault current path.

Closets

- Is this a nonhabitable room?



Article 100

- Raceway definition no longer contains specifications such as “metallic” or “nonmetallic”. Note a cable tray system is not a raceway but a support system for cables raceways (392.2)
- Receptacle definition revised to include SQL Receptacles.
- Intersystem Bonding Termination –

SQL Receptacle

PLUG-IN 1-2-3 Easy Installation

Step 1
Install power
plug into ceiling
junction box.

Step 2
Plug fan motor
into receptacle.

Step 3
Attach blades.

Optional one-step
light kit installation.



Intersystem Bonding Termination

Not new



**Arlington's GB5
Grounding Bridge**
provides intersystem
bonding between
power and
communication
grounding
systems.

Plastic Cover
*Textured,
paintable
for good looks*

Coming soon
Bronze GBBS

Layin Lug
*Grounding
conductor
goes here*

**GB5 has
four termination
points – one more
than required by
250.94 (2008 NEC) – and
the capacity to handle multiple
hookups of communications
systems.**

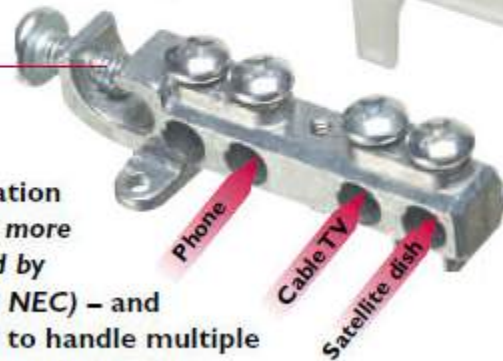

GB5
Patent
pending

**Arlington's GB5
Grounding Bridge**
provides intersystem
bonding between
power and
communication
grounding
systems.

Plastic Cover
*Textured,
paintable
for good looks*

Coming soon
Bronze GBBS

Layin Lug
*Grounding
conductor
goes here*

**GB5 has
four termination
points – one more
than required by
250.94 (2008 NEC) – and
the capacity to handle multiple
hookups of communications
systems.**

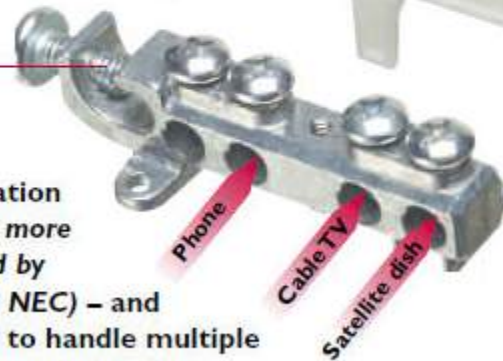

GB5
Patent
pending



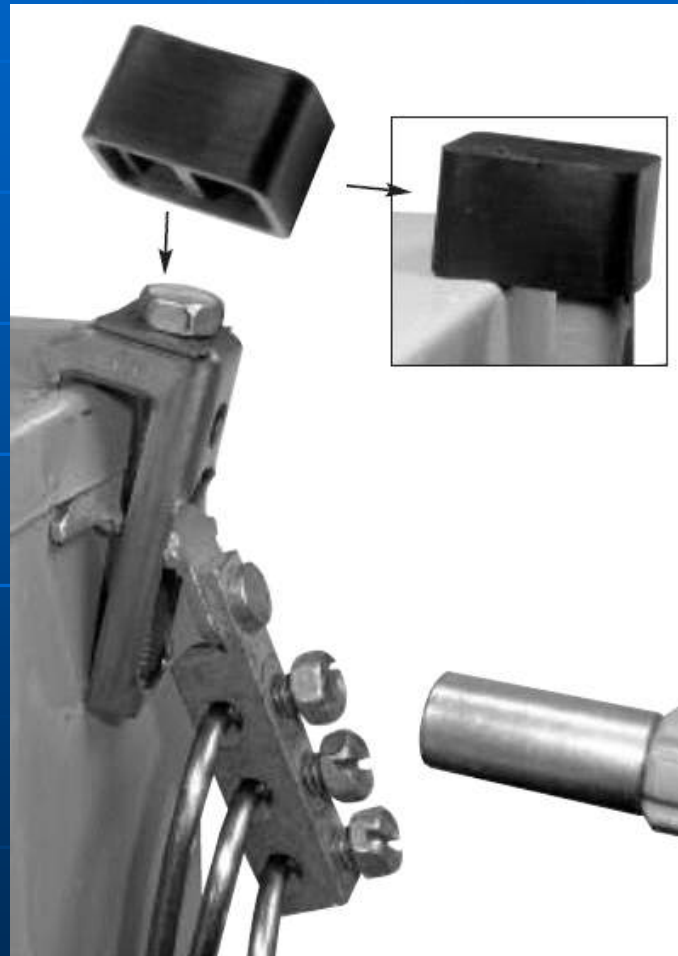







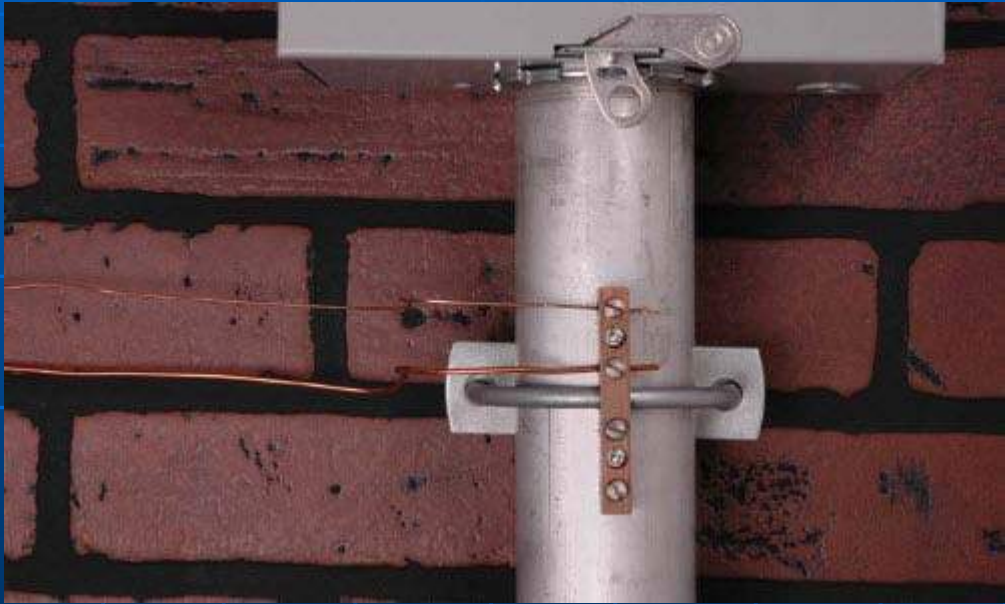

Article 100

- Receptacle vs Receptacle Outlet
- Discuss Tommy Davis and “Tommy Ties”.

Article 110

- 110.1 New Note refers us to new Annex J for ADA requirements. 2011
- 110.3(B) Clarifies that equipment that is listed, labeled, or both shall be installed in accordance with the instructions included with the listing or labeling.
- 110.5 Informational note re. copper-clad aluminum moved into the rule..

Article 110

- 110.14 (C) Temperature Limitations not new.
- 110.14 (D) **Approved means** shall be used to achieve the indicated torque value. See 3 informational notes.



Article 110

- 110.14 Identified for finely stranded conductors. Also look at finely stranded per Chapter 9 Table 10. UL Listing USUALLY only applies to Class B. Table 8 is Class B Stranding.
 - 7 on terminal indicates 75 degrees
 - 9 indicates 90 degrees
 - Flex indicates fine stranded conductors
Table 8 is Class B Stranding.

Article 110

- 110.16 Arc-Flash Warning clarifies that labels may be factory or field installed. New requirements for contents of label. Over 1200 amps specific requirements.
- 110-21 New requirements for field installed labels, applies to all labels. 2014.

Arc Flash Marking

	
WARNING	
Arc Flash and Shock Hazard Appropriate PPE Required	
24 inch	Flash Hazard Boundary
3	cal/cm² Flash Hazard at 18 inches
1DF	PPE Level, 1 Layer 6 oz Nomex®, Leather Gloves, Faceshield
480 VAC	Shock Hazard when Cover is removed
36 inch	Limited Approach
12 inch	Restricted Approach - 500 V Class 00 Gloves
1 inch	Prohibited Approach - 500 V Class 00 Gloves
Equipment Name: Surry Pump Starter	
Courtesy E.I. du Pont de Nemours & Co.	

110.16 indicates that equipment may be "Field or Factory Marked"

Article 110

- 110.22 In other than one or two family dwellings disconnects must be marked to indicate the source of supply.

Article 110 - 2011

- 110.24 Big Change – Available Fault Current must be marked – other than dwelling units. Including anytime a modification is done that may change the available fault current. Electrician usually does not calculate fault current, *but is responsible for marking!*

Article 110

- 110.26 Panic hardware when required must be listed – Note lower voltage requirement – 1000 volts. Outdoor installations must comply. Not new
- .

Article 200

- 200.4 Neutral Conductors of multiple circuits must be grouped with their corresponding ungrounded conductors – formerly applied to only multi-wire circuits Applies to all enclosures, not just panelboards. 2014
- 200.6 Neutral Conductor identification Clarified. Gray stripes allowed. 2014

Article 200 - 2011

- 200.7 White switch legs must be re-identified. 2014

Article 210 Branch Circuits

- 210.4 Simultaneous Disconnecting means for all Multiwire Branch Circuits. Note reminds us that multi-pole breaker satisfies this requirement and may be required in some circumstances. Now mirrors 200.4(B)

Article 210 Branch Circuits

- 210.5 Identification of ungrounded conductors by *phase* and *system* where more than one voltage system is present on the premises. Exception explains what to do if a new voltage is added to an existing installation.

Article 210 GFCI

- 210.8 Expanded use of GFCI up to 250V
- 6' of Bathtubs or shower stalls.
- 6' from sink in dwelling may include Range, cooktop, or oven if receptacle.
- Laundry Areas (not just within 6' of sink) Would include dryer.

- Dwelling Basements, not just unfinished basements.

Article 210

- 210.8 GFCI Requirements Clarifies that the distance from a sink is measured “as the shortest path without piercing a floor, wall, ceiling, or fixed barrier”. Also window. No mention of doors. Removes the question regarding the need for GFCI for receptacle in a cabinet under a sink. Also may require GFCI for a receptacle in another room but within 6' of a tub or sink.

Article 210

- Dwelling Unit GFCI requirement voltage increased to 250 volt no amperage limitation. So would include RV receptacle at a dwelling. Problem – Probably won't work due to additive leakage on multiple circuits. Boat receptacles per 555 require GFCI protection at 30 ma not 5 ma.

Article 210

- 210.8(B) Other than dwelling unit requirements increased to 50 amp single phase and 100 amp 3 phase. Also 120 – 250 volt. 150V or less to ground.
- 210.8(D) refers you to 422.5 which requires ALL dishwashers and other appliances to be GFCI protected.
- 210.8(F) ALL OUTDOOR OUTLETS (not receptacles) up to 50 amps must be GFCI protected. Includes A/C units! Exception for lighting outlets.

Article 210

210.11 (C)(4) Garage Receptacle outlets must be on a separate 20 amp circuit. Outdoor receptacle outlets also allowed. ONLY RECEPTACLE OUTLETS.

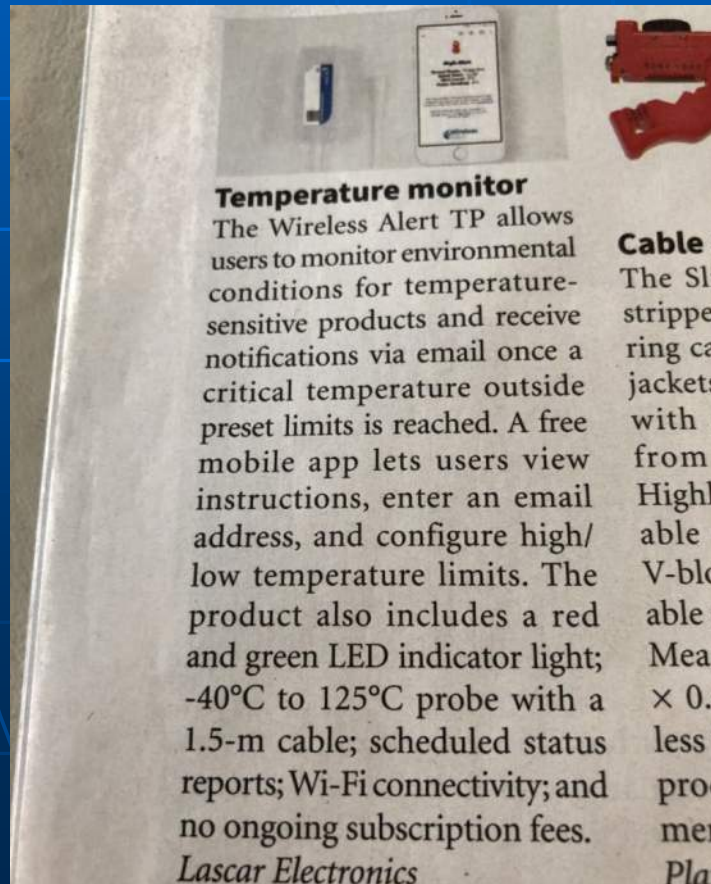

Article 210

- Non-dwelling garages GFCI protection expanded. All receptacles required, formerly receptacles for electrical diagnostic equipment, electrical hand tools, or portable lighting. Consistent with rules that require GFCI due to location not use.
- GFCI Required for automotive vacuum machines, high pressure spray washing machines, tire inflation for public use, and vending machines. Moved to 422.5

Article 210

- 210.12 Arc-Fault Protection now required for outlets or DEVICES. Added Kitchens and Laundry Areas to areas requiring AFCI. Devices includes switches so a switch in an area that requires AFCI that controls a load in a non-AFCI area would now require AFCI. Not new 2014

AFCI/GFCI Breaker



Article 210 Branch Circuits

- 210.12 (C) Dormitory units, Guest Suites, sleeping areas in nursing homes and limited-care areas now require AFCI.
- 210.18 Branch-Circuit rating moved from 210.3.
- 210.19 Branch Circuit minimum conductor ampacity rule clarified by referencing 110.14(C) termination requirements.

Article 210.19(A)(1) Exception 2

Table 310.16 for 90°C conductor insulation. The 90°C conductors are not permitted to extend into the supply or the load terminations to the circuit. ▶Figure 210-41

Conductor Sizing, Branch Circuit
90°C Equipment Terminals
210.19(A)(1) Ex 2

The 100 percent at 90°C conductors are not permitted to extend into the supply or the load terminations to the circuit.

90°C Rated Terminals

A section of conductors that terminates in a junction box at both ends to 90°C terminals per 110.14(C)(2) can have an ampacity of not less than 100% of the continuous and 100% of the noncontinuous loads based on the 90°C column of Table 310.16 for 90°C conductor insulation.

Copyright 2020, www.MikeHolt.com

Figure 210-41

Author's Comment:

As stated by CMP-2, "Ampacity is the maximum

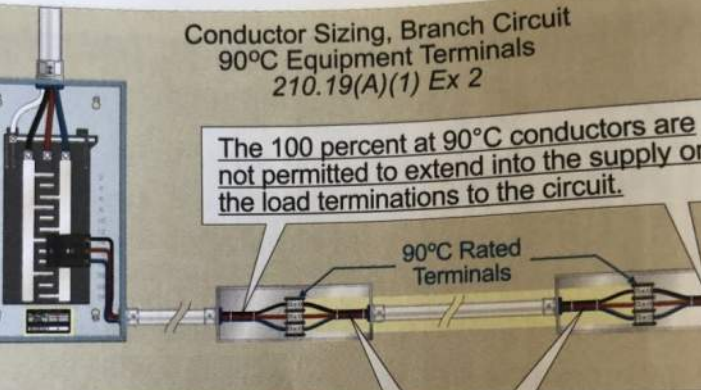
The diagram shows a cross-section of a branch circuit. On the left, a vertical panel contains a circuit breaker. Three conductors (two black and one red) are connected to the breaker. These conductors run horizontally through a section of conduit. At each end of this section, the conductors terminate in a terminal block labeled "90°C Rated Terminals". The conductors are shown with a yellow insulation layer. The diagram is annotated with a callout box stating that 100% ampacity conductors cannot extend into the supply or load terminations. Below the diagram, a text block explains that a section of conductors terminating in a junction box at both ends to 90°C terminals can have an ampacity of not less than 100% of the continuous and 100% of the noncontinuous loads based on the 90°C column of Table 310.16.

Article 210 Branch Circuits

- 210.52 Changes to dwelling unit receptacle locations most having to do with countertops.
- (A) (1) A countertop on a cabinet makes it wall space. Peninsula dividing a kitchen from a dining room will be considered wall space for the dining room.

Countertop Receptacle



Article 210

ARTICLE 210 —

Δ (1) Wall Spaces. Receptacle outlets shall be installed so that no point along the wall line is more than 600 mm (24 in.) measured horizontally from a receptacle outlet in that space.

Exception: Receptacle outlets shall not be required directly behind a range, counter-mounted cooking unit, or sink in the installation described in Figure 210.52(C)(1).

N (2) Island and Peninsular Countertops and Work Surfaces. Receptacle outlets shall be installed in accordance with 210.52(C)(2)(a) and (C)(2)(b).

(a) At least one receptacle outlet shall be provided for the first 0.84 m² (9 ft²), or fraction thereof, of the countertop or work surface. A receptacle outlet shall be provided for every additional 1.7 m² (18 ft²), or fraction thereof, of the countertop or work surface.

(b) At least one receptacle outlet shall be located within 600 mm (2 ft) of the outer end of a peninsular countertop or work surface. Additional required receptacle outlets shall be permitted to be located as determined by the installer, designer, or building owner. The location of the receptacle outlets shall be in accordance with 210.52(C)(3).

Island Receptacles



the intended seating area in this photo need to be counted in the receptacle outlet requirements for a kitchen island? At present,

Island/Peninsula Receptacles

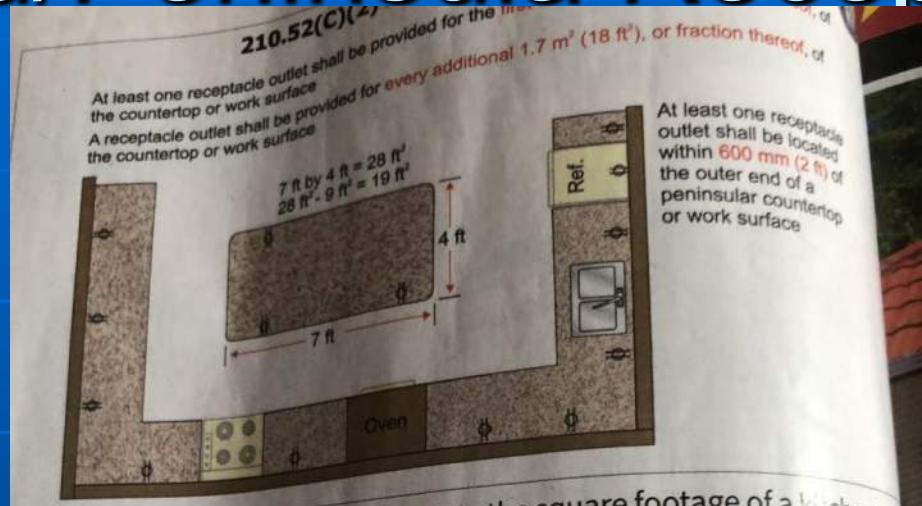

1. This illustration shows how to calculate the square footage of a kitchen island.

210.52(C)(2) Island and Peninsulas

Examples of Minimum Number of Receptacle Outlets Required

Total Square Footage of Countertop	Minimum No. of Receptacle Outlets
8 sq. ft.	1
9 sq. ft.	1
More than 9 sq. ft. up to 27 sq. ft. [9 sq. ft. + 18 sq. ft. = 27 sq. ft.]	2
28 sq. ft. [first 9 sq. ft. (one), additional 18 sq. ft. (one) and addition fraction thereof (1 sq. ft.) (one)]	3
48 sq. ft. [48 sq. ft. - 9 sq. ft. = 39 sq. ft.] [39 sq. ft. ÷ 18 sq. ft. = 2.17 sq. ft.]	4

210.52(C)(2)(a) Island and Peninsular Countertops and Work Surfaces

At least one receptacle outlet shall be provided for the first 0.84 m² (9 ft²), or fraction thereof, of the countertop or work surface.

A receptacle outlet shall be provided for every additional 1.7 m² (18 ft²), or fraction thereof, of the countertop or work surface.

Countertop Receptacles

Circle 27 on Reader Service Card

SECURE • NO-GLUE INSTALLATION OF A VARIETY OF DEVICES with ARLINGTON'S...

COUNTERTOP BOX KITS

WITH STAINLESS STEEL OR BLACK TRAPDOOR COVERS



FLBT4400GSS
Stainless steel

FLBT4400CBL Black
UL Listed
20A decorator-style
Tamper and Weather-resistant
GFCI receptacle



Arlington* 800/233-4717 • www.aifittings.com

Arlington's **Countertop BOX KITS** give you *lots of options* for installing a device in a countertop. **Get your kit with an installed UL Listed tamper and weather resistant (TWR) decorator-style GFCI... Or tamper resistant (TR) receptacle... OR a combo with (TR) receptacle and two USB ports!**

- Flexible spring clip bends to insert in opening; secures box against underside of counter by tightening screws
- Stainless steel or black TRAPDOOR COVERS look great and close flush with the countertop – providing 'ingress protection' and preventing damage to devices in the box
- Complies with NEC 406.5 (E) for use on countertops, or similar surfaces

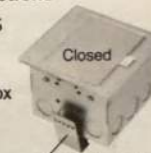

Spring clip holds box to underside of countertop



FLBT4400USS
UL Listed
20A decorator-style
TR receptacle, (2) USB ports



FLBT4400SS
UL Listed
20A decorator-style
TR receptacle



**IP44
Rated**

Patent pending

Circle 28 on Reader Service Card

210 Branch Circuits

- 210.52(D) clarifies that bath receptacle cannot be more than 12" below top of basin. 2014
- 210.52(E)(1) outdoor receptacles must be accessible FROM grade level, not while standing at grade. Back to where we were! 2014
- 210.52(G)(1) receptacle must be installed IN each "vehicle bay"! Even multifamily.

210.52

- Definition of wall space revised to exempt fixed cabinets. An entire wall of bookcases would now not require a receptacle UNLESS COUNTERTOP INCLUDED. – 2011 and 2017
- 210.52(I) Foyer Receptacles, walls space must be unbroken by windows and/or doorways that extend to the floor. 2014
- 210.52(G)(2) If run power to accessory building must have receptacle. 2014
- 210.52(G)(3) Each unfinished portion of a basement requires a receptacle. 2014

210 Branch Circuits

- 210.52(E)(3) Receptacle exemption for decks and porches less than 20 square feet is gone! All decks and porches now require a receptacle regardless of size. 2011
- 210.52(E)(3) A deck, porch, or balcony that is 4" horizontally of the dwelling requires a receptacle.

210

- 210.63 requires a receptacle near equipment requiring servicing. Includes service equipment. HVAC all occupancies. Service does not include one and two-family dwellings.

210.63

210 — BRANCH CIRCUITS

ceptacle
allation

3.7 linear m (12 linear ft) or major fraction thereof of show window area measured horizontally at its maximum width.

not be
laundry
pants.

Δ 210.63 Equipment Requiring Servicing. A 125-volt, single-phase, 15- or 20-ampere-rated receptacle outlet shall be installed at an accessible location within 7.5 m (25 ft) of the equipment as specified in 210.63(A) and (B).

not be
ties are

N (A) Heating, Air-Conditioning, and Refrigeration Equipment. The required receptacle outlet shall be located on the same level as the heating, air-conditioning, and refrigeration equipment. The receptacle outlet shall not be connected to the load side of the equipment's branch-circuit disconnecting means.

one-
least
ed in
e in

Exception: A receptacle outlet shall not be required at one- and two-family dwellings for the service of evaporative coolers.

hed
hall
m

Δ (B) Other Electrical Equipment. In other than one- and two-family dwellings, a receptacle outlet shall be located as specified in 210.63(B)(1) and (B)(2).

mit
ach

N (1) Indoor Service Equipment. The required receptacle outlet shall be located within the same room or area as the service equipment.

c-
e-

N (2) Indoor Equipment Requiring Dedicated Equipment Spaces. Where equipment, other than service equipment, requires dedicated equipment space as specified in 110.26(E), the required receptacle outlet shall be located within the same room or area as the electrical equipment and shall not be connected to the load side of the equipment's branch-circuit disconnecting means.

210.65 Meeting Rooms.

(A) **General.** Each meeting room of not more than 93 m² (1000 ft²) in other than dwelling units shall have outlets for nonlocking-type, 125-volt, 15- or 20-ampere receptacles. The number of outlets shall be installed in accordance with 210.65(B) for a room or space is provided with

210.65

210.65 Meeting Rooms.

(A) **General.** Each meeting room of not more than 93 m² (1000 ft²) in other than dwelling units shall have outlets for nonlocking-type, 125-volt, 15- or 20-ampere receptacles. The outlets shall be installed in accordance with 210.65(B). Where a room or space is provided with movable partition(s), each room size shall be determined with the partition in the position that results in the smallest size meeting room.

Informational Note No. 1: For the purposes of this section, meeting rooms are typically designed or intended for the gathering of seated occupants for such purposes as conferences, deliberations, or similar purposes, where portable electronic equipment such as computers, projectors, or similar equipment is likely to be used.

Informational Note No. 2: Examples of rooms that are not meeting rooms include auditoriums, schoolrooms, and coffee shops.

Δ (B) Receptacle Outlets Required. The total number of receptacle outlets, including floor outlets and receptacle outlets in fixed furniture, shall not be less than as determined in (1) and (2).

(1) **Receptacle Outlets in Fixed Walls.** The required number of receptacle outlets shall be determined in accordance with 210.52(A)(1) through (A)(4). These receptacle outlets shall be permitted to be located as determined by the installer, designer, or building owner.

Δ (2) Floor Outlets. A meeting room with any floor dimension that is 3.7 m (12 ft) or greater in any direction and that has a floor area of at least 20 m² (215 ft²) shall have at least one floor receptacle outlet, or at least one floor outlet to serve receptacle(s), located at a distance not less than 1.8 m (6 ft) from any

Article 215 Feeders

- 215.2(A)(1) Minimum ampacity rule refers you to the termination requirements in 110.14(C).
- 215.9 Feeders allowed to be protected by GFCI rather than individual circuits/devices as specified in 210.8. Allowed but problematic due to additive leakage.

Article 220

- 220.12 Now only applies to non-dwellings. Allows use of lighting values from energy codes where applicable and all conditions met.
- Big Change – Values in table 220.12 now include the 125% for continuous load. See Note to table. 125% must still be added when calculating actual lighting load.

■ .

Article 220

- 220.12(J) Explains how to calculate lighting and receptacle loads for dwellings.

Article 225

- 225.10 removed term “multiconductor cable” and added Type SE and Type TC-ER Cable. More specific.
- 225.19 Clarifies that clearance requirements applies to open conductor and open conductor cable assemblies not to cable assemblies with an overall outer cover such as SE Cable.

Article 225

- 225.30(A) Added docking facilities to the special buildings or other structures that may be fed with additional branch circuits or feeders.

Article 225

- 225.36 Type, the requirement that a disconnect be required to be suitable for use as service equipment has been revised. Suitable for use as service mostly means that the neutral and grounds (and enclosure) may be tied together using a main bonding jumper. Since using the neutral as the fault return path is only allowed in existing buildings "suitable as service" is only required in existing buildings for "non-service" disconnects.

Article 230 Services

- 230. The term “rating” has been removed in several places and replaced with the more accurate term “ampacity”.
- 230.43 TC-ER Cable added to the list of acceptable wiring methods for service-entrance conductors.
- 230.46 Requires distribution blocks and several other splicing methods to be listed. Not effective until January 1, 2023.

Article 230

- 230.62(C) Adds barriers in service equipment to avoid contact by persons when servicing load terminations.

Article 230 Services

(B) Guarded. Energized parts that are not enclosed shall be installed on a switchboard, panelboard, or control board and guarded in accordance with 110.18 and 110.27. Where energized parts are guarded as provided in 110.27(A)(1) and (A)(2), a means for locking or sealing doors providing access to energized parts shall be provided.

(C) Barriers. Barriers shall be placed in service equipment such that no uninsulated, ungrounded service busbar or service terminal is exposed to inadvertent contact by persons or maintenance equipment while servicing load terminations.

Δ 230.66 Marking.

(A) General. Service equipment rated at 1000 volts or less shall be marked to identify it as being suitable for use as service equipment. All service equipment shall be listed or field evaluated.

(B) Meter Sockets. Meter sockets shall not be considered service equipment but shall be listed and rated for the voltage and current rating of the service.

Exception: Meter sockets supplied by and under the exclusive control of an electric utility shall not be required to be listed.

N 230.67 Surge Protection.

(A) Surge-Protective Device. All services supplying dwelling units shall be provided with a surge-protective device (SPD).

(B) Location. The SPD shall be an integral part of the service equipment or shall be located immediately adjacent thereto.

Exception: The SPD shall not be required to be located in the service equipment as required in (B) if located at each next level distribution equipment downstream toward the load.

(C) Type. The SPD shall be a Type 1 or Type 2 SPD.

(D) Replacement. Where service equipment is replaced, all of the requirements of this section shall apply.

Article 230

- 230.67 Requires Surge Protection (SPD) for all dwelling unit services.
- 230.71 Requires a single disconnect for each service unless the requirements of 230.71(B) are met.

Article 230.85 Emergency Disconnect

230.85 Emergency Disconnects

For one- and two-family dwelling units, all service conductors must terminate in a disconnecting means having a short-circuit current rating equal to or greater than the available fault current and installed in a readily accessible outdoor location. If more than one disconnect is provided, they must be grouped. Each disconnect must be one of the following:

- (1) Service disconnects marked: **EMERGENCY DISCONNECT, SERVICE DISCONNECT**
- (2) Meter disconnects installed in accordance with 230.82(3) must be marked: **EMERGENCY DISCONNECT, METER DISCONNECT, NOT SERVICE EQUIPMENT**
- (3) Other listed disconnect switches or circuit breakers on the load side of the meter and supply side of each service disconnect marked: **EMERGENCY DISCONNECT, NOT SERVICE EQUIPMENT**

Markings must be permanently affixed and have sufficient durability to withstand the environment involved in accordance with 110.21(B).

Article 230.85

Author's Comment:

- ▶ Option (1) permits an outside service disconnect to be both the service disconnect and the emergency disconnect. In some areas it is already common to locate the service disconnect on the exterior and the only thing that changes in those cases is the new marking that is required.
- ▶ Option (2) permits a meter disconnect to serve as the required emergency disconnect. This is useful where the utility has required the installation of a meter disconnect. The meter disconnect must be installed in accordance with the requirements of 230.83(3) and must be marked.
- ▶ Option (3) provides for the installation of other listed disconnect switches or circuit breakers that are suitable for use as service disconnects and are marked as such.

Article 240 Overcurrent Protection

- 240.6 Standard ampere rating now in a table. About time!

Article 242

- New article replaces old articles 280 and 285. Surge Protection Devices (SPD's) have been combined in this new article. Logical location Article 240 describes how to protect equipment from overcurrent, 242 describes how to protect from overvoltage.
- 242.8 SPD's must be listed.

Article 250 Grounding and Bonding

- 250.6 Clarifies that electronic equipment must be connected to an equipment bonding conductor even if it results in “objectionable current” (noise). The term noise has been replaced with “electromagnetic interference”.
- 250.12 revised to require clean surfaces for bonding connections as well as grounding connections.



Article 250

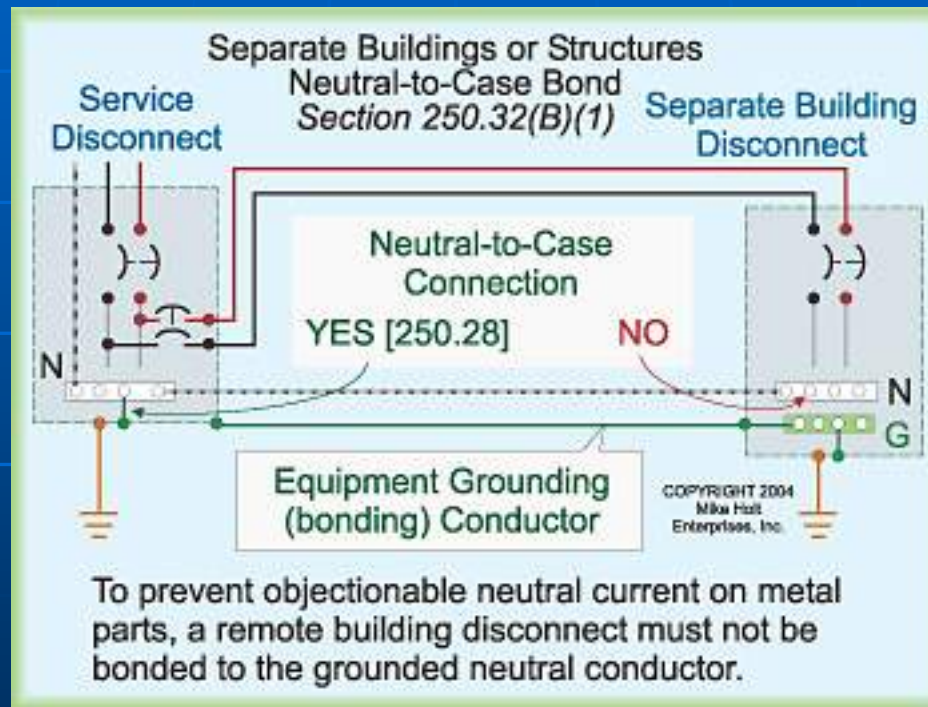

Article 250 Grounding and Bonding

- 250.25(A) Clarifies that systems connected on the supply side of the service disconnect (ie. Solar, Wind) must comply with 250.24 (A) through (D).
- 250.25(B) applies to ungrounded systems. The result is that systems connected to the supply side of a service disconnect being installed identically to the installation of service equipment.

Article 250 Grounding and Bonding

- 250.30(A)(6) Clarifies that water pipe can be used as the grounding electrode for multiple separately derived systems. Also clarifies the size of bussbars.
- 250.52 Clarifies that structural metal (now called "metal in-ground support structure(s)") is allowed as a grounding electrode and prohibits the use of swimming pool steel as an electrode.
- 250.53 Installation requirements for ground rings clarified. We now "install" a ground ring instead of "burying" it.

Generator Grounding

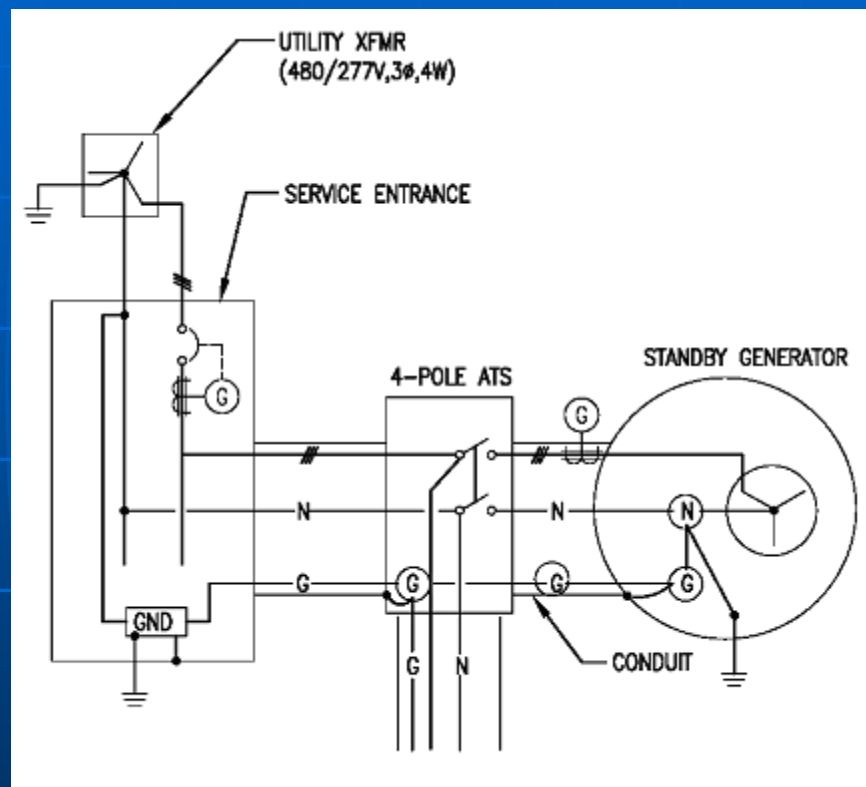

WHEN THE GENERATOR IS CONSIDERED A SEPARATELY DERIVED SOURCE, THE NEUTRAL AND GROUND ARE TIED TOGETHER AT THE GENERATOR AND A FOUR-POLE ATS MUST BE USED. THE NEUTRAL IS SWITCHED AT THE ATS.

Generator Grounding

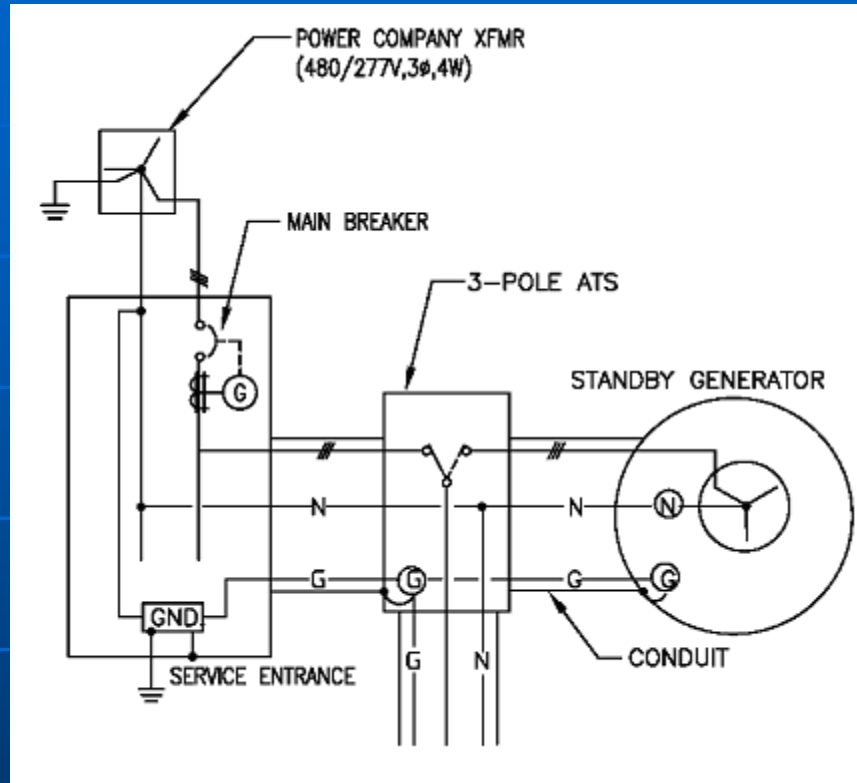

WHEN THE GENERATOR IS NOT CONSIDERED A SEPARATELY DERIVED SOURCE, THE NEUTRAL AND GROUND ARE NOT TIED TOGETHER AT THE GENERATOR AND A THREE-POLE ATS MUST BE UTILIZED. THE NEUTRAL IS SOLIDLY CONNECTED AT THE ATS TO ALLOW THE GENERATOR NEUTRAL TO BE CONNECTED TO THE MAIN SERVICE GROUND AT ALL TIMES (WHEN THE LOAD IS BEING SERVED FROM EITHER THE MAIN SERVICE THROUGH THE SERVING ELECTRICAL UTILITY OR FROM THE STANDBY GENERATOR).

Article 250 Grounding and Bonding

- 250.30 Clarifies requirements for multiple separately derived systems. If you have multiple systems in parallel they are not separately derived since they are connected together. Such as: generator, fuel cells, PV, and Wind Generators all being paralleled together. The connected SYSTEMS must be considered a single separately derived system.
- 250.32 Clarifies that a building supplied by a feeder must have a grounding electrode system and a grounding electrode conductor (grounding Conductor)

Article 250 Grounding and Bonding

- 250.34 Term vehicle mounted generator technically did not include trailer mounted generator. Term trailer mounted has been added for clarification. Also clarifies that portable, vehicle mounted, and trailer mounted generators usually do not require a grounding electrode.
- 250.53(C) Clarifies that rebar cannot be used as a bonding jumper to interconnect grounding electrodes.

Article 250 Grounding and Bonding

- 250.68 (C)(3) Also clarifies that concrete encased electrode can extend from the concrete in order to connect to it, such as extending a piece of rebar out of the foundation. Also clarifies that the extension must be protected from direct contact with the earth.
- 250.94 *Exception* Intersystem bonding termination not required for buildings where “communication systems are not likely to be used”.
- 250.98 Bonding loosely jointed metal raceways. Clarifies that it applies to “expansion-deflection or deflection” fittings. Formerly applied only to expansion fittings. Look at manufacturer instructions. Some expansion fitting are suitable for bonding, some require bonding jumpers.

Article 250 Grounding and Bonding

- 250.104(A) New language. Never required to be larger than 3/0 copper or equivalent. Does not apply to isolated sections of metal water piping connected to a nonmetallic water system.

Article 250 Grounding and Bonding

- 250.109 Specifically permits metal enclosures to be used as part of the effective ground fault return path. Common practice, now specifically allowed.

250.119 Identification of grounding conductors, allows green to be used for conductors other than grounds for zip cord and traffic signals.

Article 250

- 250.121 Restricted Use of Equipment Grounding Conductors.
 - (A) Not used as Grounding Electrode conductor.
 - (B) Metal frame of building or structure not to be used as equipment grounding conductor.
- 250.122(B) Increased in size except for Ambient Temperature and Fill.

Article 250

- 250.130 Another method for replacing non-grounding receptacles. A viable method for increasing the safety of existing wiring. Use grounding conductor from another circuit. 2014
- 250.148 Clarifies that ALL equipment grounding conductors in an enclosure must be connected together. Word "any" replaced by "all".

Article 250

- 250.146(A) Surface mounted box. Acceptable return path under certain conditions.

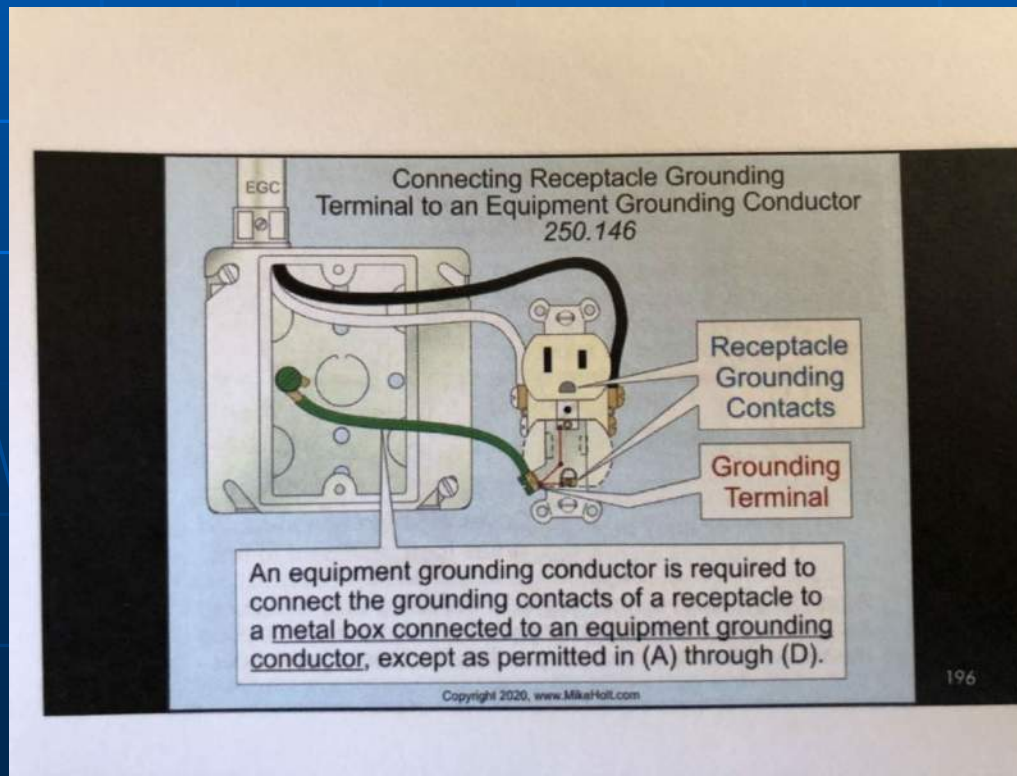

Article 285 Surge Protection Devices 2014

- Moved to Article 242.

Article 300 General Requirements for Wiring Methods and Materials

- 300.3(B) Language added to ensure that when connections, taps, or extensions are made from parallel conductors, all conductors from each phase or neutral are included.
- 300.4(G) Clarifies bushing requirements for #4 and larger conductors.
- 300.7 Requires sealants to be “identified”..

Article 300 General Requirements for Wiring Methods and Materials

- 300.22 Wiring in ducts. Normally limited to wiring to equipment located in the duct. New exception allows other wiring in the duct if it does not exceed 4' in length. 2017

Article 310

- 310.1 Scope changed to limit voltage covered by 310 up to 2000 volts. Higher voltage conductors addressed in new Article 211.
- 310.6 relocated from 310.110(C) word grounding was revised to equipment grounding for clarity.

Article 310 Conductors for General Wiring

- 310.12 Dwelling Unit Table is back! It was removed and replaced with a confusing calculation 310.15(B)(7) 2014
- 310.15(A)(2) Relocated to 310.14(A)(2) Exception Higher ampacity is permitted if the reduced ampacity section does not exceed 10' or 10% of raceway length

Article 310

- 310.15(B)(2) Rooftop ampacity. Pretty much gone unless less than 7/8" above roof.
- Table 310.16 is back! Was 310.15(B)(16).

Article 312 Cabinets, Cutout Boxes, and Meter Socket Enclosures

- 312.5 Requires cables to be securely fastened to enclosures. Exception for cable trays.
- 312.5(C) Exception allows cables to be sleeved into enclosure if ALL conditions are met.

Article 312

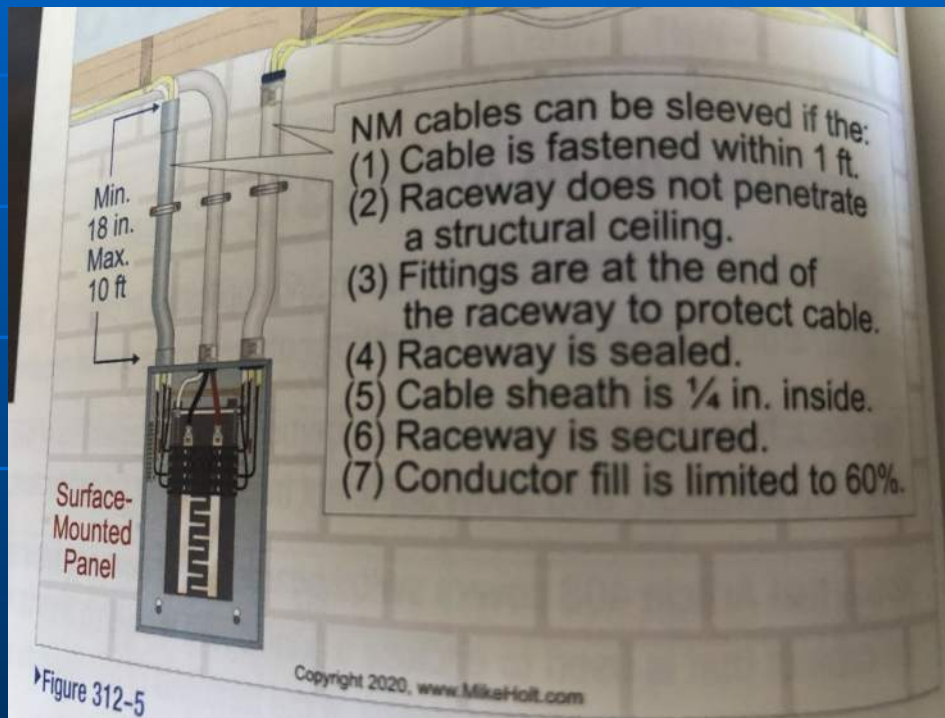

Article 312

- 312.8 Allows other equipment in a switch or overcurrent device enclosure with limitations.

Article 314 Outlet, Device, Pull, Boxes, etc.

- 314.16 Refers you to 314.24 which requires sufficient depth in a box to allow devices without damage to conductors. Think GFCI and AFCI receptacles.
- 314.6(B)(5) Deduction for grounding conductor. $4=1$ deduction. Each grounding conductor over $4=1/4$.

Article 314

- 314.27(C) Paddle fan boxes.
Required in most dwelling locations if suitable for future paddle fan. Or provides access to structure for support of fan.
- 314.29 New rules for accessibility of boxes, conduit bodies, and handhole enclosures both in buildings and underground.

Article 314

- 314.20 Clarifies that flush mounting rules apply to all surfaces, not just walls and ceilings.
- 314.23 Field made mounting holes must be approved.
- 314.27(C) If a “spare” conductor is installed in a ceiling outlet which would be suitable for a paddle fan, the box must be listed for the support of a paddle fan. –
2011

Article 314

- 314.27(E) Special purpose
Receptacles may now support stuff.

SQL Receptacle

PLUG-IN 1-2-3 Easy Installation

Step 1

Install power
plug into ceiling
junction box.

Step 2

Plug fan motor
into receptacle.

Step 3

Attach blades.

Optional one-step
light kit installation.

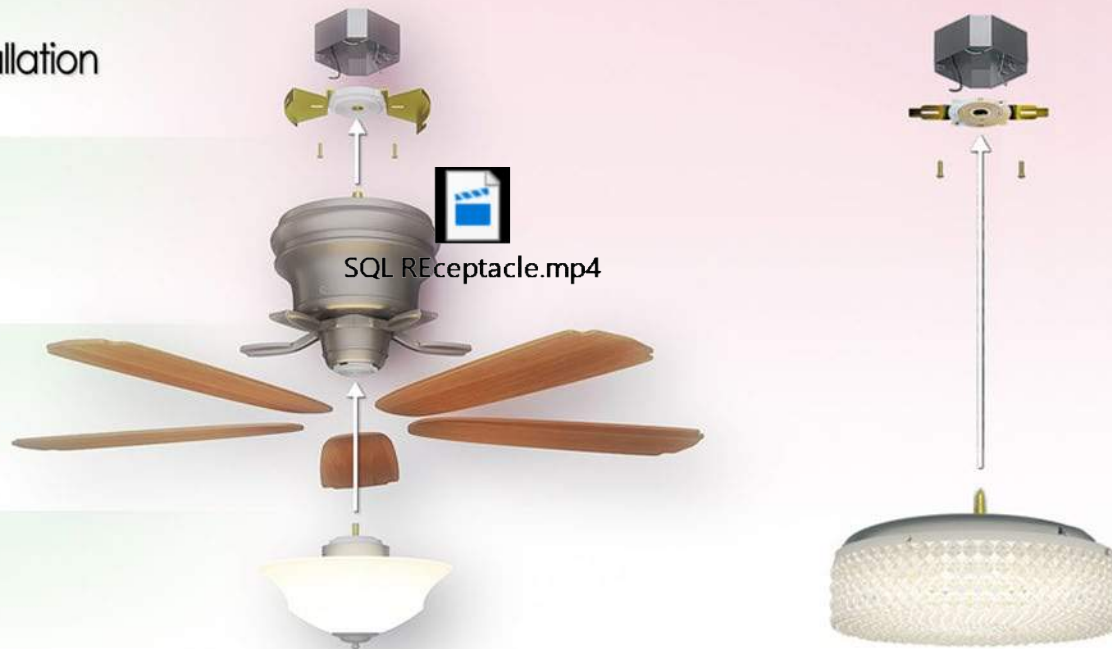

SQL Receptacle



SQL REceptacle.mp4

Article 320 – Armored Cable

- 320.2 See definition applies throughout code. In every wiring method article.
- 320.23 Guard Strips – required within 7' of permanently installed stairs 6' of scuttle hole.
- 320.80(A) Ampacity adjustment if more than 2 AC Cables each containing 2 or more current carrying conductors in contact with insulation without maintaining spacing.

Article 330 MC Cable

- 330.80 same restriction as AC Cable for contact with insulation.
- 330.15 New requirements for exposed MC added. Nothing really new it was just never addressed (.15 section was missing.)

Article 334 NM Cable

- 334.12 (A)(2) Clarifies that NM cannot be installed within a dropped ceiling cavity except in dwellings. Previously said “in a dropped ceiling”.
- 334.30 Clarifies that length between last support and entering the box shall not exceed 18”. Also clarifies installing NM in a raceway. YES YOU CAN!!!!!!.

Article 338 SE and USE

- 338.2 Clarifies that SE and USE Cable has an overall covering. A service-entrance conductor assembly has no overall covering.
- 338.10(B) USE cable is not permitted to be installed indoors.

Article 340 Type UF

- 340.10 Revised list regarding permitted uses.
- 340.12(9) New informational note advises that sunlight resistant marking on jacket does not apply to the individual conductors within the jacket unless they are also identified.

342 IMC

- 342.10 New wording in (E) clarifies that IMC is suitable for use where subject to severe physical damage.
- 342.14 Addresses the issue of Dissimilar Metals.

Article 344 RMC

- 344.10 Same clarification for severe physical damage as IMC
- 344.14 Clarifies dissimilar metal concerns.

Article 350 Liquidtight Flexible Metal Conduit LFMC

- 350.10 Permitted uses expanded.
- 350.12 Revised into a single sentence prohibiting use where subject to physical damage.
- 350.30 Securing and Supporting. Last sentence explains that listed fitting as support applies only to the exceptions.

356 Type LFNC

- 356.10 Uses Permitted expanded.
- Note: When using conductors at their 75 degree rating you need to make sure that the LFMC has the correct rating. One brand is marked 80 degree C for dry locations and 60 degree C in wet locations!

358 EMT

- 358.10 new (E) added to permit steel and stainless steel EMT to be installed where subject to physical damage.
- 358.12 prohibits the use of EMT where exposed to severe physical damage. I can't find a definition for either!!!!

Article 392 Cable Trays

- 392.22 Conductor fill sizing calculations clarified. Based on the size of the compartment not the entire area of the tray.

380 Multioutlet Assemblies

- 380.12(7) Prohibits cord and plug connection. Multioutlet assembly that is intended for cord and plug connection is a “relocatable power tap” and are not intended for permanent installation.

Article 400 Flexible Cords & Flexible Cables

- Title clarifies that the article applies to FLEXIBLE cables not all cables. Limited energy cables such as coax and twisted pairs are not covered by 400.
- 400.12 clarifies that article 400 applies to extension cords and power supply cords. Note that the NEC applies to installation not use. It is not a code violation for me to run the vacuum cord through a doorway while I am using it.

400

- 400.12 Uses not permitted. Clarifies that Article 400 applies to cord sets and power cords and they are not allowed above suspended ceilings.

Article 404 & 406

- 404.2(C) Requires a neutral conductor at *nearly* every switch point. Wording revised to “habitable rooms and occupiable spaces so required in dwelling and non-dwelling occupancies.
- 404.4(C) Clarifies that switches are not allowed in tub spaces or shower spaces.
- 404.9 “Grounding” of metal faceplates clarifies that they are required to be connected to an equipment grounding conductor not just grounded..

Article 406



Wet or damp locations shall be Weather-Resistant Receptacles.

Porches, decks and other outdoor locations are all examples of wet or damp locations and are challenging environments where cracked covers or corrosion can cause premature failure. New Pass & Seymour Weather-Resistant Receptacles were designed to comply with this code.

Features & Benefits

- Listed to the Weather-Resistant supplement of UL498, meeting demanding UL® requirements including:
 - Ultraviolet light exposure test
 - Cold impact test
 - Accelerated aging test
 - Stringent material requirements for current-carrying parts, wire binding screws and mounting straps to ensure superior corrosion resistance
- Residential Weather-Resistant Receptacles are Tamper-Resistant as required by 2008 NEC.
- All receptacles are cULus listed.
- Receptacles still require a weatherproof cover in wet or damp locations.
- WR marking on face as required by UL Standard.

Applications

- Required for wet and damp locations such as outdoor, roofed or open porches, canopies, basements, barns, and wash-down areas.

Weather-Resistant Receptacle Ordering Information

Catalog Number	Description	Listed to FSUL WC596	Rating A. V.	Color
3232TRWR*†	TradeMaster® Duplex Receptacle		15 125	Brown, I, LA, W
885TRWR**	TradeMaster Decorator Receptacle		15 125	Brown, I, LA, W
1595TRWR*†	TradeMaster Specification Grade GFCI Receptacle	•	15 125	Brown, I, LA, W
WR5262*	Specification Grade Straight Blade Duplex Receptacle	•	15 125	GRY, I, W
WR5262*	Specification Grade Straight Blade Duplex Receptacle	•	20 125	GRY, I, W



3232TRWR*



1595TRWR*



WR20TR*



Article 406

- 406.4 Ungrounded receptacles allowed for replacements.
- 406.5(G)(2) Receptacles under sinks not allowed to be mounted face up.
- 406.5(E) Allows listed assemblies for countertop receptacles.
- 406.9(C) Clarifies receptacle distance from tubs and how to handle very small bathrooms.



AFCI Receptacle



Article 406

- 406.4(D) Replacement of non-grounding receptacles.
- Notes
 - 1. Where equipment instructions require an equipment grounding conductor a non-grounding type receptacle is not permitted.
 - 2. Where equipment grounding is required by 250.114 a non-grounding type receptacle is not permitted.

Article 406

- Replacement receptacles may also require AFCI Protection. There are exceptions but since AFCI/GFCI dual rated receptacles are available they don't really apply.

Article 406

- 406.5 Clarifies that receptacles installed in countertops in any orientation must be listed for countertop installation. Installed in a work surface it can be listed for a countertop or work surface. In any case if it is installed face up, it must be listed for countertop or work surface installation.

Article 406

- 406.6 Faceplates generally are not required to be listed. However if they include USB Ports or Night lights they must be listed

Article 406

- 406.12 Use of Tamper Resistant Receptacles expanded. Tamper resistant required where “boys” are.

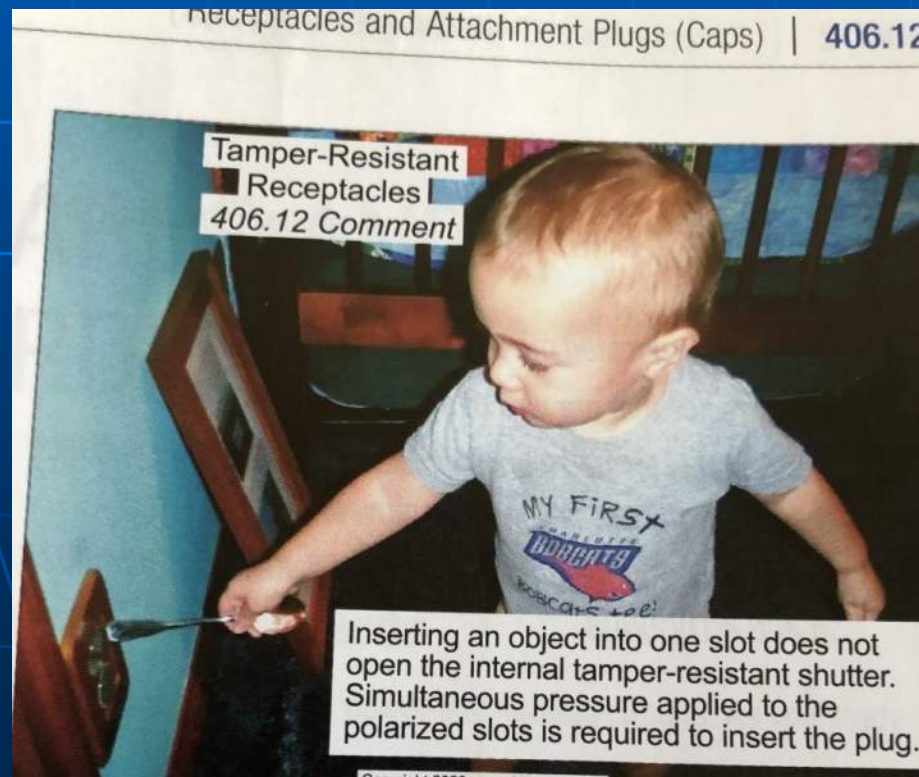

Article 408 Switchboards and Panelboards

- 408.8 Addresses the reconditioning of equipment.
- 408.23 Addresses the installation of power monitoring equipment in switchboards and switchgear. See 312.8(B).
- 408.36 exception 2. Permissive instruction as been eliminated but existing installations grandfathered in.
- 408.43 Prohibits panelboards being installed face up. Which of you was dong this???

Article 410 Luminaires, etc.

- 410.2 Closet Storage Space revised to Clothes Closet Storage Space for clarification. This definition is a single sentence of 125 words. May be longest in the NEC!
- 410.6 Luminaire retrofit kits must be listed.
- 410.7 Prohibits the use of reconditioned luminaires, etc. and describes what is considered reconditioning.
- 410.10 Luminaires under roof decking must follow same spacing as wiring and boxes (1.5 inches). 2017

Article 410

- 410.10(D) Luminaires in bathtub/shower areas clarified.

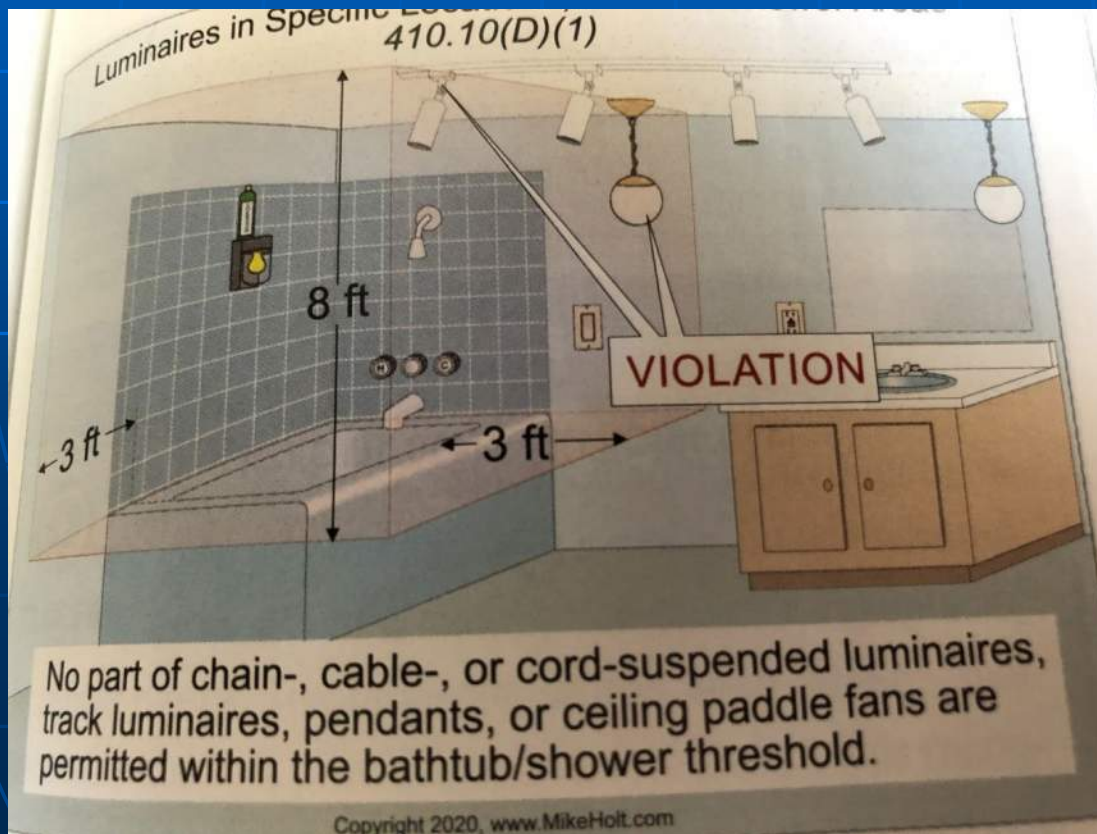

Article 410

- 410.40 Grounding of luminaires clarified as attached to equipment grounding conductor.
- 410.130 Exception allowing “Qualified Persons” to be electrocuted while changing ballasts was eliminated. 2017

Article 410

- 410.16 Title already specified “Clothes Closets” but wording was changed throughout to clarify that it applies only to clothes closets.
- 410.22 Clarifies that entire opening around a lighting outlet must be covered.

Article 410

- 410.36 Revised to allow SQL Type device (described in 314.27(E)) to support luminaires.
- 410.40-46 Clarifies the “grounding” of luminaires.

Article 410

- 410.116(C) Prohibits the installation of luminaires marked “For use in non-fire-rated installations” in fire-rated installations.
- 410.118 Access to other boxes. New section now prohibits a common practice.

Article 410

- New Part XVI dealing with Horticultural Lighting Equipment (Grow Houses).

Article 411 Low Voltage Lighting

- 411.4 Clarifies the listing requirements for low voltage lighting and prohibits the reconditioning (does not prohibit repair) of such systems.

Article 422 Appliances

- 422.5 Relocated GFCI Requirements for appliances to this section. Sump pumps were added! All dishwashers now require GFCI not just dwellings.
- 422.6 Clarifies Listing requirement.
- 422-10 Ampacity of circuit conductors must not be less than the marked rating of the appliance. See last paragraph for household ranges and cooking appliances!.

Article 422

- 422.13 Water heater. Changed back to 125% no longer “considered a continuous load.”
- 422.16 Use of flexible cords to connect appliances clarified.
- 422.31 Use of overcurrent device as appliance disconnect clarified.

424 Fixed Electric Space Heating

- 424.4 Revised text for sizing conductors and overcurrent devices for electric space heating and associated motors.

Article 430 Motors

■ 430.2 New Definition of “Electronically Protected Motors”

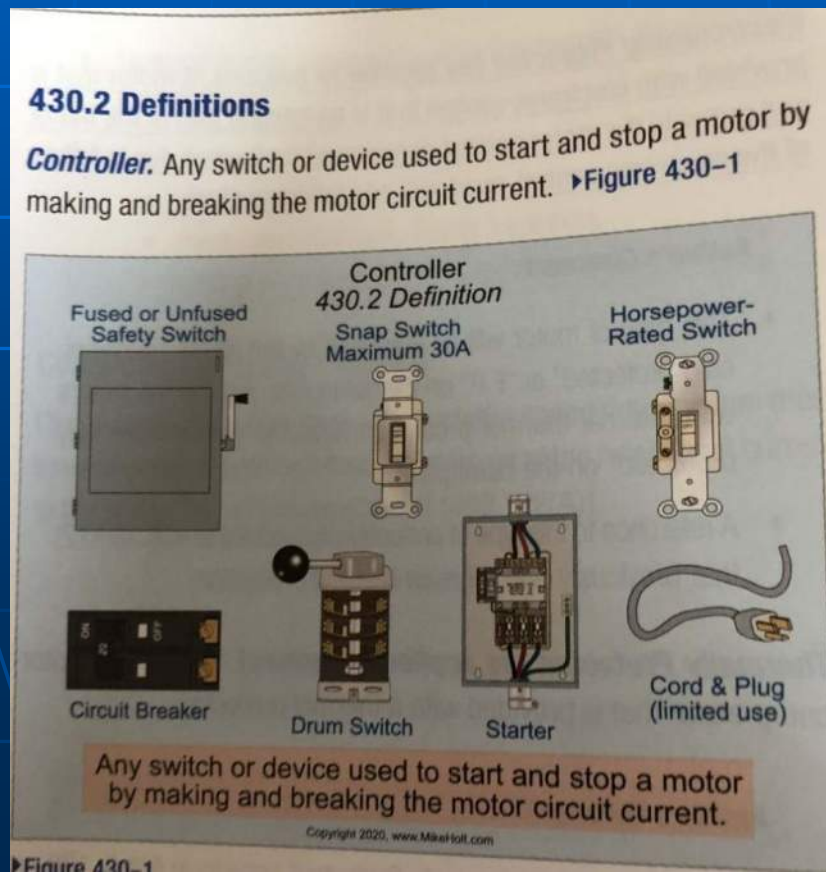

Article 430

- 430.32(A)(2) and (B)(2) add Electronically Protected to ways to protect motors from overload.
- 430.122 new informational note warning of possible breakdown of conductors associated with adjustable speed drives.

Article 430

- 430.130 See new exception and informational notes regarding adjustable speed drives.

Article 440 Air-Conditioning

- 440.9 A wire type equipment ground is now required for some air-conditioning installations. Clarifies that compression type connectors are not suitable for grounding. Previously said fittings must be threaded and compression fittings have threads.
- 440.10 Section with short-circuit current rating requirements clarified

Article 440 Air-Conditioning

- 440.32 Clarifies the method of selecting the minimum branch-circuit conductor ampacity.
- Learn to read the nameplate and do not overthink air conditioner wiring!
- MCA = minimum circuit ampacity which includes 125%.
- Max Fuse/Circuit Breaker size means what it says!

Article 445 Generators

- 445.6 Stationary Generator 600V or less required to be listed.
- 445.18 Clarification of disconnecting means and emergency shutdown of prime mover. Title change

Article 445 Generators

445.18 | Generators



NEW

445.18(D) Emergency Shutdown Means in One- and Two-Family Dwelling Units. The concern behind subsection (D) is that if a firefighter must shut down the utility power the generator may automatically start and put the first responders in danger unless they have a readily accessible means to shut it down too. The *NEC* language does not require the emergency shutdown device to be in a specific location, only that it be outside at a readily accessible location. If the device required by 445.18(B) is located outside at a readily accessible location, that device would be permitted to serve as the shutdown device required by this section.

445.18 Disconnecting Means and Emergency Shutdown

(A) Disconnecting Means. Generators, other than cord-and-plug-connected portable generators, must have one or more disconnecting means. Each disconnecting means shall be readily accessible to the associated phase.

Article 445 Generators

- 445.20 Finally a clarification of GFCI requirements! 2017

Article 450 Transformers

- 450.9 Ventilation Expanded to include a requirement for top horizontal surfaces of transformers to be marked to prohibit storage.
- 450.14 Requires that a remote disconnecting means must be lockable in the open position.

Article 480 Storage Batteries

- 480.2 Definition revised.
- 480.3 Most batteries must now be listed! 2017
- 480.7(B) Emergency disconnect requirement to match other 1 and 2 family dwelling exterior disconnect requirements.

Article 480 Storage Batteries

- 480.10 Egress from battery rooms same as egress from electrical rooms.
- 480.13 Ground Fault DETECTION required in some circumstances. Not the same as ground fault protection.

Article 500 Hazardous Locations

- 500.4 Name changed from “General” to “Documentation”. Content is same. Generally not the electrician's job to classify a location, just to understand how to install in a classified area.
- 500.8 (G) new subsection addressing the risk of ignition from sources of optical radiation (such as laser or LED)

Article 501 Class I Locations

- 501.10 Language was changed to clarify that both threaded and threadless fittings may be used with IMC and RMC in Class I, Division 2 locations. Previously indicated that only threadless fittings were allowed.

Article 514 Motor Fuel dispensing Facilities - 2011

- 514.11 All conductors must be SIMULTANEOUSLY disconnected, including grounded, communications, data and video. This seems to have always been the intent, but now the wording is clear. Disconnection of grounded conductors has been required from 1959 – 2014 but was not clear in 2017. Also clarifies that EGC must not be disconnected.

Article 517 Health Care Facilities

- 517.2 Definitions Clarified. Only apply to 517.
- 517.10 Clarifies area to which 517 does NOT apply.
- 517.16 Isolated Ground receptacles are NOT permitted in patient care areas (2011). IG defeats the purpose of the redundant ground.
- 2020 allows their use but it is very limited and a distinction is made between “patient care area” and “patient care vicinity”!

518 Assembly Occupancies

- 518.6 Requires illumination for working space about fixed service equipment when located outdoors.

Article 547 Agricultural Buildings

- 547.2 Clarifies that definitions in this section apply only to Article 547. Equipotential plane as defined in 547 different than definition in Article 100.
- 547.5 the allowance for non-GFCI protected receptacles was removed, so receptacles will need GFCI regardless of the use. 2014 See confusing GFCI requirements for receptacles other than 125 volt 15 and 20 amps.

Article 550 Mobile Homes, etc.

- 550.13 Dishwashers in Mobile and manufactured homes must be GFCI Protected. However confusing language would seem to require GFCI only on receptacles for dishwashers which would conflict with 422 and then note refers you to 422?
- 550.15 Prohibition of aluminum wire removed..

Article 555 Marinas, Boatyards, And Commercial and

noncommercial docking facilities.

- 555.1 Title and many provisions revised changed to include residential installations. Floating buildings now covered in 555, article 553 is gone.
- 555.5 Maximum voltage for dock or marina services was reduced from 1000 volts to 250 volts phase to phase.

Article 555

- 555.9 Boat hoist GFCI requirement relocated from Article 210. Note it is for outlets not just receptacles.
- 555.13 Bonding of noncurrent-carrying metal parts. Similar to pools?

Article 555

- 555.35 Ground Fault Protection for equipment and personnel. 30ma for shore power. 100ma for feeders. Standard article 210.8 GFCI protection for “general use” receptacles.
- 555.35(B) Leakage detection equipment required if more than 3 shore power receptacles.

Article 555

- 555.37 Specifies equipment that must be connected to the equipment grounding conductor.
- New part III applies to Floating Buildings
- 555.53 Requires 100ma GFPE on main or GFI protection on each individual feeder or branch circuit.

Article 590 Temporary Installations

- 590.4 Allows the use of SE Cable and open splices are allowed ANYWHERE for temporary wiring.
- 590.6 Now allows "special purpose GFCI's for receptacles...? Class C, D, and E. Trip at 20 ma instead of 6 ma.

Article 600 Signs

- 600.1 Retrofit kits for signs are covered by this article.
- 600.2 New definition for Photovoltaic (PV) Powered sign.
- 600.3 PV Powered signs must be listed.

604 Manufactured Wiring Systems

- 604.6 Must now be listed.

625 Electric Vehicle Charging

- 625.2 definitions Wireless Power Transfer (like pad for cell phones)
- 625.5 Listing requirement clarified. Was not enforceable as previously written.

Article 680 Pools, etc.

- A. GFCI Required on all pool pump motors
- B. Receptacle required within 20' of all pools not just dwellings.
- C. 680.26 pool water bonding....

Article 680 Pools, etc.

- A. GFCI Required on all pool pump motors
- B. Receptacle required within 20' of all pools not just dwellings.
- 680.11 Underground wiring...

Article 680 cont'd

- 680.23(F)(2) Listed low voltage luminaires that do not require grounding do not need an equipment grounding conductor. - 2011

Article 680 cont'd.

- 680.26 Equipotential Bonding revised AGAIN. If structural reinforcing steel does not extend 3' an alternate means must be provided which can be an 8 AWG solid copper conductor installed 18-24 inches from the pool 4-6" below the subgrade. All metal parts connected to the bonding grid.
- (C) Pool water must be bonded by a minimum 9 sq. in. in contact with the water. 2008 requirement

Permanently Installed Pools Bonding Metal Parts *Section 680.26(B)(1)*

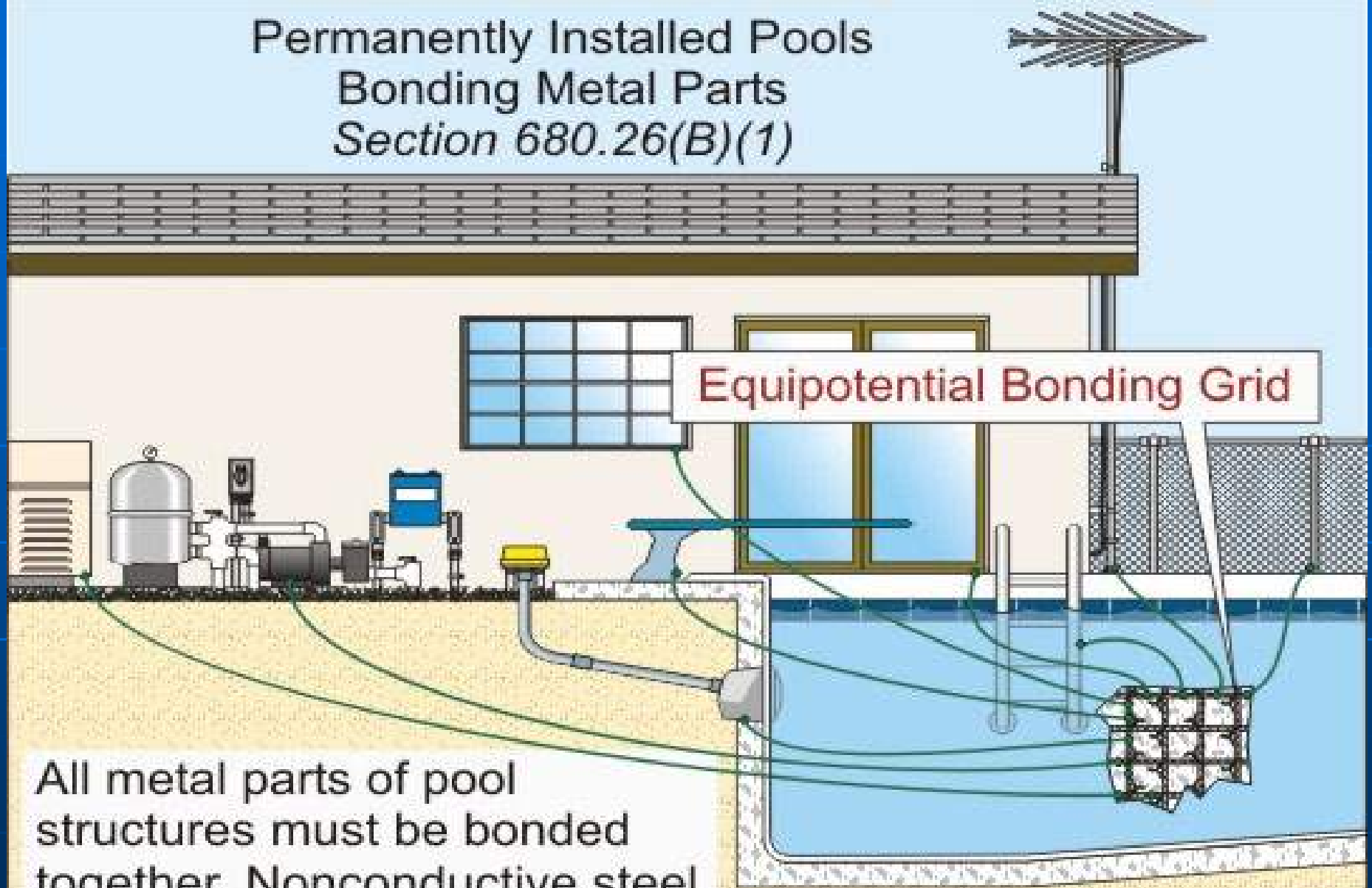

All metal parts of pool structures must be bonded together. Nonconductive steel cannot be used because it does not eliminate voltage gradients.

Equipotential Bonding Perimeter Surfaces Section 680.26(B)(2)(b)

18 to 24 in. From
Inside Wall of Pool

8 AWG Bare
Solid Copper

Perimeter
Surface

Article 680 cont'd.

- 680.43 Equipotential bonding for perimeter surfaces don't apply to a listed self contained spa or hot-tub installed above a finished floor. - 2011

Article 690 PV System

- See 690.4(E) Requires that PV equipment, etc. must ONLY be installed by QUALIFIED PERSONS. This is the first time that such a requirement has been incorporated in the NEC. This could foreshadow a new direction..... 2014

THE END

- As always:
 - Questions
 - Comments
 - Complaints
 - Suggestions???
-
- Thank you for your attention and participation.